

FAIRCHILD
A Schlumberger Company

IRF710-713
MTP2N35/2N40 T-39.09
N-Channel Power MOSFETs,
2.25 A, 350-400 V
Power And Discrete Division

Description

These devices are n-channel, enhancement mode, power MOSFETs designed especially for high speed applications, such as switching power supplies, converters, AC and DC motor controls, relay and solenoid driver and high energy pulse circuits.

TO-220AB

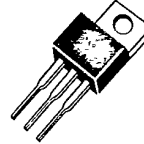

1500010F

- Low $R_{DS(on)}$
- V_{GS} Rated at ± 20 V
- Silicon Gate for Fast Switching Speeds
- I_{DSS} , $V_{DS(on)}$ Specified at Elevated Temperature
- Rugged
- Low Drive Requirements
- Ease of Paralleling

IRF710
IRF711
IRF712
IRF713
MTP2N35
MTP2N40

Maximum Ratings

Symbol	Characteristic	Rating IRF710/712 MTP2N40	Rating IRF711/713 MTP2N35	Unit
V_{DSS}	Drain to Source Voltage ¹	400	350	V
V_{DGR}	Drain to Gate Voltage ¹ $R_{GS} = 20$ k Ω	400	350	V
V_{GS}	Gate to Source Voltage	± 20	± 20	V
T_J , T_{stg}	Operating Junction and Storage Temperatures	-55 to +150	-55 to +150	$^{\circ}C$
T_L	Maximum Lead Temperature for Soldering Purposes, 1/8" From Case for 5 s	275	275	$^{\circ}C$

Maximum On-State Characteristics

		IRF710-711	IRF712-713	MTP2N35/40	Unit
$R_{DS(on)}$	Static Drain-to-Source On Resistance	3.6	5.0	5.0	Ω
I_D	Drain Current				A
	Continuous at $T_C = 25^{\circ}C$	1.5	1.4	1.3	
	Continuous at $T_C = 100^{\circ}C$	1.0	0.9	0.8	
	Pulsed	6.0	5.0	5.0	

Maximum Thermal Characteristics

					Unit
$R_{\theta JC}$	Thermal Resistance, Junction to Case	6.4	6.4	2.5	$^{\circ}C/W$
$R_{\theta JA}$	Thermal Resistance, Junction to Ambient	80	80	80	$^{\circ}C/W$
P_D	Total Power Dissipation at $T_C = 25^{\circ}C$	20	20	50	W

Notes
For information concerning connection diagram and package outline, refer to Section 7.

IRF710-713
MTP2N35/2N40

T-39-09

Electrical Characteristics ($T_C = 25^\circ\text{C}$ unless otherwise noted)

Symbol	Characteristic	Min	Max	Unit	Test Conditions
Off Characteristics					
$V_{(BR)DSS}$	Drain Source Breakdown Voltage ¹			V	$V_{GS} = 0\text{ V}, I_D = 250\ \mu\text{A}$
	IRF710/712/MTP2N40	400			
	IRF711/713/MTP2N35	350			
I_{DSS}	Zero Gate Voltage Drain Current		250	μA	$V_{DS} = \text{Rated } V_{DSS}, V_{GS} = 0\text{ V}$
			1000	μA	$V_{DS} = 0.8 \times \text{Rated } V_{DSS}, V_{GS} = 0\text{ V}, T_C = 125^\circ\text{C}$
I_{GSS}	Gate-Body Leakage Current		± 500	nA	$V_{GS} = \pm 20\text{ V}, V_{DS} = 0\text{ V}$
On Characteristics					
$V_{GS(th)}$	Gate Threshold Voltage			V	$I_D = 250\ \mu\text{A}, V_{DS} = V_{GS}$ $I_D = 1\text{ mA}, V_{DS} = V_{GS}$
	IRF710-713	2.0	4.0		
	MTP2N35/2N40	2.0	4.5		
$R_{DS(on)}$	Static Drain-Source On-Resistance ²			Ω	$V_{GS} = 10\text{ V}, I_D = 0.8\text{ A}$
	IRF710/711		3.6		
	IRF712/713/MTP2N35/40		5.0		
$V_{DS(on)}$	Drain-Source On-Voltage ²		13	V	$V_{GS} = 10\text{ V}, I_D = 2.0\text{ A}$
	MTP2N35/2N40		10	V	$V_{GS} = 10\text{ V}, I_D = 1.0\text{ A}, T_C = 100^\circ\text{C}$
g_{fs}	Forward Transconductance	0.5		S (Ω)	$V_{DS} = 10\text{ V}, I_D = 0.8\text{ A}$
Dynamic Characteristics					
C_{iss}	Input Capacitance		200	pF	$V_{DS} = 25\text{ V}, V_{GS} = 0\text{ V}$ $f = 1.0\text{ MHz}$
C_{oss}	Output Capacitance		50	pF	
C_{rss}	Reverse Transfer Capacitance		15	pF	
Switching Characteristics ($T_C = 25^\circ\text{C}$, Figures 11, 12) ³					
$t_{d(on)}$	Turn-On Delay Time		10	ns	$V_{DD} = 200\text{ V}, I_D = 0.8\text{ A}$ $V_{GS} = 10\text{ V}, R_{GEN} = 50\ \Omega$ $R_{GS} = 50\ \Omega$
t_r	Rise Time		20	ns	
$t_{d(off)}$	Turn-Off Delay Time		10	ns	
t_f	Fall Time		15	ns	
Q_g	Total Gate Charge		7.5	nC	$V_{GS} = 10\text{ V}, I_D = 2.0\text{ A}$ $V_{DD} = 200\text{ V}$

IRF710-713
MTP2N35/2N40 T-39.09

Electrical Characteristics (Cont.) ($T_C = 25^\circ\text{C}$ unless otherwise noted)

Symbol	Characteristic	Typ	Max	Unit	Test Conditions
V_{SD}	Diode Forward Voltage				$I_S = 1.5 \text{ A}; V_{GS} = 0 \text{ V}$
	IRF710/711		1.6	V	
	IRF712/713		1.5	V	
t_{rr}	Reverse Recovery Time	380		ns	$I_S = 1.5 \text{ A}; di_S/dt = 25 \text{ A}/\mu\text{S}$

- Notes
- $T_J = +25^\circ\text{C}$ to $+150^\circ\text{C}$
 - Pulse test: Pulse width $\leq 80 \mu\text{s}$, Duty cycle $\leq 1\%$
 - Switching time measurements performed on LEM TR-58 test equipment.

Typical Performance Curves

Figure 1 Output Characteristics

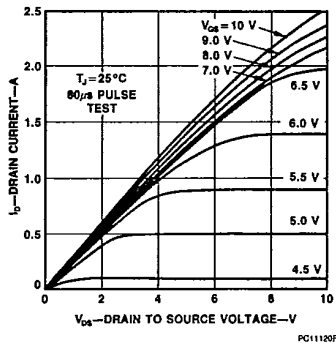

Figure 2 Static Drain to Source Resistance vs Drain Current

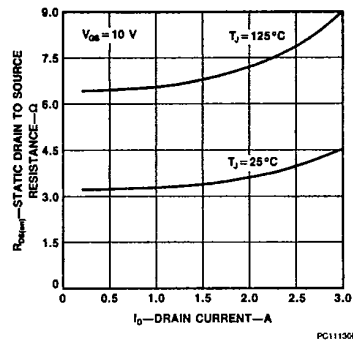

Figure 3 Transfer Characteristics

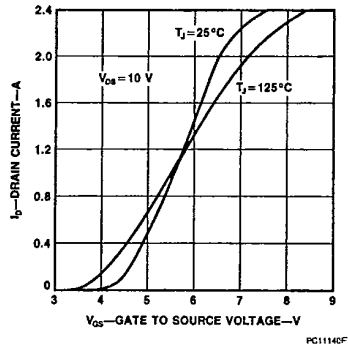
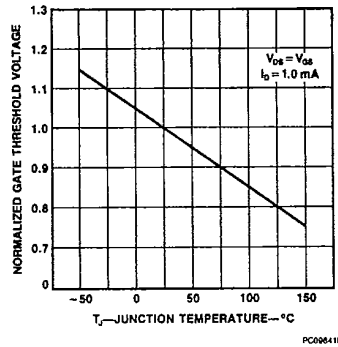

Figure 4 Temperature Variation of Gate to Source Threshold Voltage



IRF710-713
MTP2N35/2N40

T-39.09

Typical Performance Curves (Cont.)

Figure 5 Capacitance vs Drain to Source Voltage

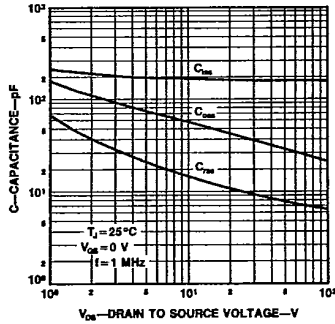

PC11150F

Figure 6 Gate to Source Voltage vs Total Gate Charge

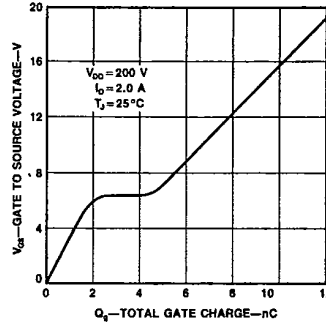

PC11160F

Figure 7 Forward Biased Safe Operating Area for MTP2N35/2N40

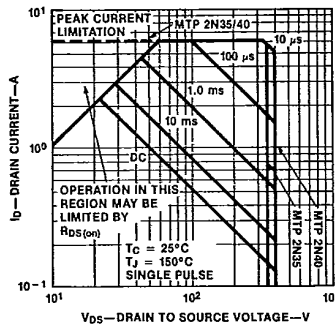

PC11171F

Figure 8 Transient Thermal Resistance vs Time for MTP2N35/2N40

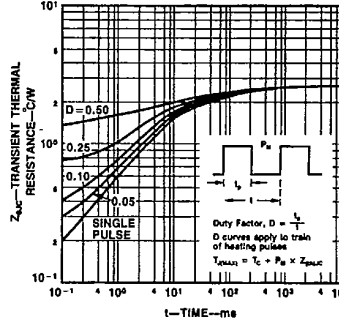

PC11051F

Figure 9 Forward Biased Safe Operating Area for IRF710-713

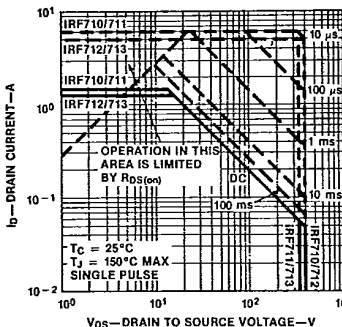

PC1209CF

Figure 10 Transient Thermal Resistance for IRF710-713

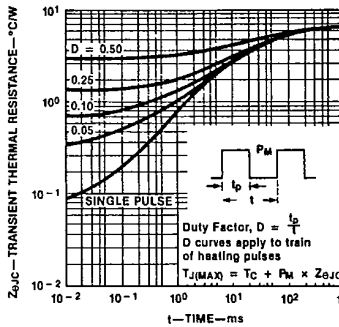

PC12070F

Typical Electrical Characteristics

Figure 11 Switching Test Circuit

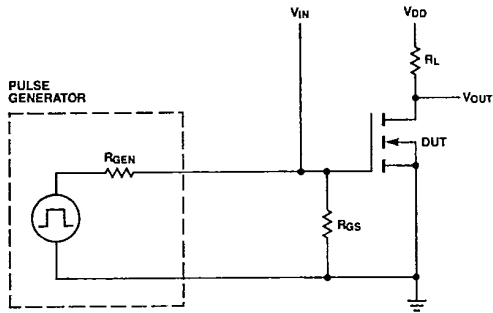

CR0445CF

Figure 12 Switching Waveforms

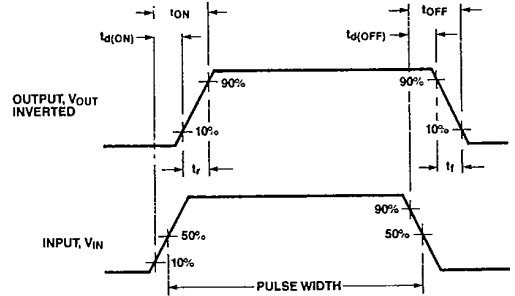

AF0060F

Handwritten notes and a stamp in the bottom right corner.